





Modèle Model	Description	Puissance Power	Finition Finishing stage	Prix HTVA Price excluding VAT
SP1	Foyer en fonte, sortie des fumées 100 diam. <i>Cast-iron hearth, smoke outlet 100 diam.</i>	8,5 KW	Verre Glass	3.670,00 €
			Pierre Stone	4.050,00 €
		9,5 KW	Verre Glass	3.770,00 €
			Pierre Stone	4.150,00 €
		11 KW	Verre Glass	3.870,00 €
			Pierre Stone	4.250,00 €

Finition verre disponible en noir, blanc et bordeaux
Glass finish available in black, white, burgundy



SP135

(Bientôt
disponible)

Option Kit UP (MODELS S; U ; I)

375,00 €



SP137

Kit de canalisation diam. 80mm
80 mm pipes canalisation kit

185,00 €



SP015

n°27

VENTILATEUR POUR LA CANALISATION
FAN FOR THE PIPE (5M max)

Compatible
8,5kw /9,5kw
/11kw

285,00 €



SP036

KIT PRISE D'AIR (conduit flexible blanc,
extensible de 500 à 1500 mm
AIR INTAKE KIT - White flexible pipe,
extensible from 500 to 1500 mm)

52 mm diam. int.
70 mm diam. ext.

35 €

Modèle Model	Description	Puissance Power	Finition Finishing stage	Prix HTVA Price excluding VAT
UP1  * Socle en bois en option Wooden base in option ** Le UP1 sans pied requiert l'option Kit UP UP1 without base requires Kit UP option	Foyer en fonte, sortie des fumées 100 diam., pied en acier Cast-iron hearth, smoke outlet 100 diam., steel base	8,5 KW	Avec pied With base	3.800,00 €
			Sans pied ** Without base**	
		9,5 KW	Avec pied With base	3.900,00 €
			Sans pied ** Without base**	
		11 KW	Avec pied With base	3.990,00 €
			Sans pied ** Without base**	



SP135

(Bientôt disponible)

Option Kit UP (MODELS S; U ; I)

375,00 €



SP137

Kit de canalisation diam. 80mm
80 mm pipes canalisation kit

185,00 €



SP015

n°27

VENTILATEUR POUR LA CANALISATION
FAN FOR THE PIPE (5M max)

Compatible
8,5kw /9,5kw
/11kw

285,00 €



SP036

KIT PRISE D'AIR - Conduit flexible blanc,
extensible de 500 à 1500 mm
AIR INTAKE KIT - White flexible pipe,
extensible from 500 to 1500 mm)

52 mm diam. int.
70 mm diam. ext.

35 €

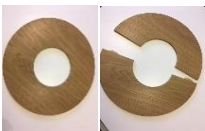

SP138

Socle en bois
Wooden base

125,00 €

Modèle Model	Description	Puissance Power	Finition Finishing stage	Prix HTVA Price excluding VAT
TP1 	Foyer en fonte, sortie des fumées 100 diam. <i>Cast-iron hearth, smoke outlet 100 diam.</i>	8,5 KW	Acier Steel	4.050,00 €
			Verre Glass	4.550,00 €
			Pierre Stone	4.950,00 €
		9,5 KW	Acier Steel	4.150,00 €
			Verre Glass	4.650,00 €
			Pierre Stone	5.050,00 €
		11 KW	Acier Steel	4.250,00 €
			Verre Glass	4.750,00 €
			Pierre Stone	5.150,00 €

Actuellement non disponible - Currently not available



SP137		Kit de canalisation diam. 80mm <i>80 mm pipes canalisation kit</i>	185,00 €
-------	--	--	----------



SP015	n°27	VENTILATEUR POUR LA CANALISATION <i>FAN FOR THE PIPE (5M max)</i>	Compatible 8,5kw /9,5kw /11kw	285,00 €
-------	------	---	-------------------------------------	----------



SP036		KIT PRISE D'AIR - Conduit flexible blanc, extensible de 500 à 1500 mm <i>AIR INTAKE KIT - White flexible pipe,</i> <i>extensible from 500 to 1500 mm</i>	52 mm diam. int. - 70 mm diam. ext.	35 €
-------	--	---	--	------

Modèle Model	Description	Puissance Power	Finition Finishing stage	Prix HTVA Price excluding VAT	
IP1	Foyer en fonte, sortie des fumées 100 diam. <i>Cast-iron hearth, smoke outlet 100 diam.</i>	8,5 KW	Acier Steel	3.370,00 €	
			Verre Glass	3.510,00 €	
			Pierre Stone	3.790,00 €	
			9,5 KW	Acier Steel	3.470,00 €
				Verre Glass	3.610,00 €
				Pierre Stone	3.890,00 €
		11 KW	Acier Steel	3.570,00 €	
			Verre Glass	3.710,00 €	
			Pierre Stone	3.990,00 €	



**Finition verre disponible en noir,
blanc et bordeaux**
*Glass finish available in black,
white and burgundy*



SP135	(Bientôt disponible)	Option Kit UP (MODELS S; U ; I)	375,00 €
--------------	----------------------	--	-----------------



SP137		Kit de canalisation diam. 80mm <i>80 mm pipes canalisation kit</i>	185,00 €
--------------	--	--	-----------------



SP015	n°27	VENTILATEUR POUR LA CANALISATION <i>FAN FOR THE PIPE (5M max)</i>	Compatible 8,5kw /9,5kw /11kw	285,00 €
--------------	------	---	-------------------------------------	-----------------



SP036		KIT PRISE D'AIR - Conduit flexible blanc, extensible de 500 à 1500 mm <i>AIR INTAKE KIT - White flexible pipe,</i> <i>extensible from 500 to 1500 mm</i>	52 mm diam. int. - 70 mm diam. ext.	35 €
--------------	--	---	--	-------------

PIECES DETACHEES DU CORPS DE CHAUFFE

Modèle <i>Model</i>	N° article	N° Vue éclatée	Description	Prix HTVA <i>Price excluding VAT</i>
------------------------	------------	----------------	-------------	---

KIT ENTRETIENS



SP140			KIT DE JOINTS POUR ENTRETIEN Joints de la porte en fonte (10mm), des trappes d'accès et de la réserve de granulés <i>Seal Kit for maintenance</i>	20,00 €
-------	--	--	---	---------

SP141			LUBRIFIANT (BASE CUIVRE) Copper based lubricant	77,00 €
-------	--	--	---	---------

PIÈCES DÉTACHÉES



SP001	7		CREUSET SUTI CRUCIBLE SUTI	65,00 €
-------	---	--	--------------------------------------	---------



SP002			DEFLECTEUR DE CREUSET SUTI CRUCIBLE DEFLECTOR SUTI	30,00 €
-------	--	--	--	---------

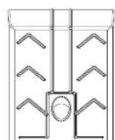



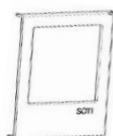



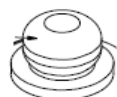

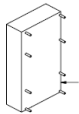

SP003	8		FOND EN FONTE SUTI CAST IRON BASE SUTI	125,00 €
-------	---	--	--	----------











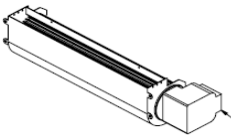



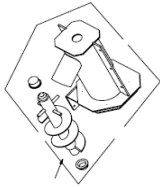

SP004			PORTE FONTE SUTI : COMPLETE VITRE AVEC JOINT CAST IRON DOOR SUTI - COMPLETE GLASS WITH JOINT	400,00 €
-------	--	--	---	----------

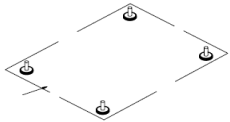

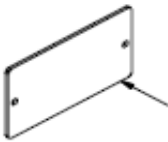
SP005	23		MOTEUR D'EXTRACTION EXTRACTION MOTOR	254,00 €
-------	----	--	--	----------

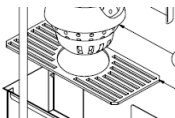
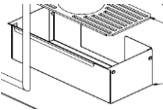
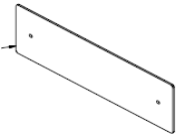
	SP006	28	MOTOREDUCTEUR DE LA VIS SANS FIN SCREW GEARMOTOR		175,00 €
	SP007	19	CARTE MERE MOTHERBOARD	LX 128 - Wi-Fi intégré	265,00 €
	SP008	20	PRESSOSTAT PRESSURE SWITCH	10-200 PA	25,00 €
	SP009	21	THERMOSTAT DE SECURITE 80° 80° SAFETY THERMOSTAT	Réserve à pellets	10,00 €
	SP0099	21	THERMOSTAT DE SECURITE 120° 120° SAFETY THERMOSTAT	Corps de chauffe	10,00 €
	SP010	30	PANNEAU SYNOPTIQUE TACTILE SYNOPTIC TOUCH PANEL		175,00 €
	SP011	29	PRISE 230 V AVEC FUSIBLES 5A, INTERRUPTEUR ON/OFF 230 V SOCKET WITH 5A FUSES ON/OFF SWITCH	Avec filtre With filter	16,00 €
	SP012	26	CAPTEUR DE PRESSION D'AIR VACUOMETRE AIR PRESSURE SENSOR VACUOMETER		60,00 €
	SP013	31	RADIOCOMMANDE RADIO REMOTE-CONTROL		150,00 €
	SP014	32	SOUPAPE DE SECURITE SAFETY VALVE	Feutre étanche	10,00 €
	SP015	27	VENTILATEUR POUR LA CANALISATION FAN FOR THE PIPE		280,00 €

	SP016	25	VENTILATEUR TANGENTIEL TANGENTIAL FAN	165,00 €
	SP017	24	JOINT ETANCHE VENTILATEUR EXTRACTEUR DE FUMÉES AIRPROOF SEAL SMOKE EXTRACTOR FAN	Feutre étanche 5,00 €
	SP018	22	BUTÉE DU MOTOREDUCTEUR SANS FIN GEARMOTOR STOP	4,00 €
	SP019	18	BAGUE D'ASSEMBLAGE DU MOTOREDUCTEUR GEARMOTOR ASSEMBLY RING	5,00 €
	SP020	17	VIS SANS FIN SCREW	248,00 €
	SP021	16	BOUGIE D'ALLUMAGE EN QUARTZ QUARTZ SPARK PLUG	80,00 €
	SP022	15	MODEM WIFI WIFI MODEM	350,00 €
	SP023	14	SUPPORT + SONDE DE TEMPERATURE AMBIANTE ROOM TEMPERATURE + PROBE SUPPORT	24,00 €
	SP024	13	JOINT PLAT DU DOS DE FLAMME ROUND BACK FLAME SEAL	7x3 mm black 4€/M
	SP025	12	PIEDS DE NIVELLEMENT LEVELLING FEET	4 pieds 7€/ piece

	SP026	11	JOINT DE LA TRAPPE 2, ZONE DE RETENTION DES CENDRES <i>TRAP 2 SEAL, ASH RETENTION AREA</i>	Feutre étanche	5,00 €
	SP027	10	SYSTÈME DE VERROUILLAGE DES PORTES <i>DOOR LOCKING SYSTEM</i>		37,00 €
	SP028	9	JOINT TRAPPE A PELLETS ETANCHE <i>AIRPROOF PELLETS TRAP SEAL</i>		5€/M
	SP029	6	GRILLE DU CENDRIER <i>ASHTRAY GRATE</i>		18,00 €
	SP030	5	CENDRIER <i>ASHTRAY</i>		35,00 €
	SP031	4	JOINT DE LA TRAPPE 1, ZONE DE RETENTION DES CENDRES <i>TRAP 1 SEAL, ASH RETENTION AREA</i>	Feutre étanche	5,00 €
	SP032	3	JOINT ROND POUR PORTE <i>ROUND SEAL FOR THE DOOR</i>	10 mm Dia. black	6€/M
	SP033	2	VITRE INTERIEURE <i>INNER GLASS</i>		150 €
	SP034	1	JOINT PLAT VITRE INTERIEURE <i>FLAT SEAL INNER GLASS</i>	7x3 mm black	5€/M
	SP035		THERMOCOUPLE (SONDE QUI LIT LA TEMPERATURE DES FUMÉES) <i>THERMOCOUPLE (PROBE THAT READS THE SMOKE TEMPERATURES)</i>		25 €



SP036	KIT PRISE D'AIR - Conduit flexible blanc, extensible de 500 à 1500 mm <i>AIR INTAKE KIT - White flexible pipe, extensible from 500 to 1500 mm)</i>	52 mm diam. int. - 70 mm diam. ext.	35 €
-------	--	--	------



SP037	KIT THERMOSTAT SÛTI (AVEC BOITIER GATEWAY) <i>THERMOSTAT KIT (WITH GATEWAY)</i>		445 €
-------	---	--	-------



SP039	GRANDE PORTE DE FINITION AVEC LE VERRE <i>BIG DOOR WITH GLASS</i>		665,50 €
-------	---	--	----------



SP040	FINITION ACIER (FLANCS GAUCHE ET DROIT) <i>STEEL COVER (LEFT AND RIGHT SIDES)</i>		172,50 €
-------	---	--	----------

SP041	TOP EN ACIER <i>STEEL TOP</i>		63,00 €
-------	---	--	---------



SP042	CHARNIERE DU HAUT DE LA GRANDE PORTE <i>TOP HINGE OF THE BIG DOOR</i>		20,50 €
-------	---	--	---------



SP043	CHARNIERE DU BAS DE LA GRANDE PORTE <i>BOTTOM HINGE OF THE BIG DOOR</i>		39,00 €
-------	---	--	---------



SP044	FUSIBLE 5 A		2,00 €
-------	--------------------	--	--------



SP045	PILE POUR THERMOSTAT <i>BATTERY FOR THERMOSTAT</i>		11,00 €
-------	--	--	---------













SP046	CAOUTCHOUC POUR MOTEUR DE VIS <i>SILENT BLOCK FOR GEAR MOTOR</i>		2,30 €
-------	--	--	--------



SP047	CONDENSATEUR MOTEUR D'EXTRACTION <i>CAPACITOR FOR EXTRACTION MOTOR</i>		6,50 €
-------	--	--	--------

	SP048	AIMANT SUPERIEUR HAUTE TEMPERATURE GRANDE PORTE <i>HT MAGNET FOR THE TOP OF THE BIG DOOR</i>	11,25 €
	SP049	AIMANT INFERIEUR GRANDE PORTE <i>MAGNET FOR THE BOTTOM OF THE BIG DOOR</i>	11,25 €
	SP050	RONDELLE EN ACIER (par 10 pcs) STEEL WASHER (per 10)	1,00 €
	SP051	BOULON NOIR GRANDE PORTE (par 10 pcs) <i>BLACK BOLT FOR BIG DOOR (per 10)</i>	1,00 €
	SP052	JOINT CREUSET et JOINT ANTI-VIBRATION <i>CRUCIBLE AND ANTI-VIBRATION SEAL</i>	5€/M
	SP053	TAPE ADHESIF H ° POUR JOINT DE LA RESERVE (10M) <i>ADHESIVE TAPE HT FOR PELLET TRAP SEAL (10 M)</i>	50,00 €
	SP054	GRILLE DE VENTILATION GRANDE PORTE <i>BIG DOOR VENTILATION GRID</i>	10,00 €
	SP055	ATTACHE PORTE EN FONTE <i>FASTENING ELEMENT FOR CAST IRON DOOR</i>	10,00 €
	SP056	AXE PORTE EN FONTE <i>PIN FOR THE CAST IRON DOOR</i>	1,75 €
	SP057	BUMPER ADHESIF POUR LE TOP (par 10 pcs) <i>ADHESIVE BUMPER FOR THE TOP (per 10)</i>	1,00 €
	SP058	SUPPORT MURAL THERMOSTAT <i>WALL HOLDER FOR THE THERMOSTAT</i>	25,00 €
	SP059	LANGUETTE EN MOUSSE POUR LE TOP <i>FOAM STRIP FOR THE TOP</i> (270 X 8 X 6 MM)	2,00 €
	SP060	CÂBLE FLAT <i>FLAT CABLE</i>	25,00 €

	SP061		FINITION SP1 VERRE NOIR SP1 BLACK GLASS FINISH	450,00 €
	SP062		FINITION SP1 VERRE BLANC SP1 WHITE GLASS FINISH	450,00 €
	SP063		FINITION SP1 VERRE BORDEAUX SP1 BURGUNDY GLASS FINISH	450,00 €
	SP064		FINITION IP1 VERRE NOIR IP1 BLACK GLASS FINISH	450,00 €
	SP065		FINITION IP1 VERRE BLANC IP1 WHITE GLASS FINISH	450,00 €
	SP066		FINITION IP1 VERRE BORDEAUX IP1 BURGUNDY GLASS FINISH	450,00 €
	SP135	(Bientôt disponible)	OPTION KIT UP (MODELS S ; U ; I)	375 €
	SP136		GANT SÛTI EN CUIR SÛTI LEATHER GLOVE	39 €
	SP137		KIT DE CANALISATION DIAM. 80mm 80 mm PIPES CANALISATION KIT	185,00 €
	SP138		SOCLE EN BOIS UP1 WOODEN BASE UP1	125,00 €
	SP139		VITRE SECURIT POUR POSER LE POELE SAFETY GLASS TO PUT UNDER THE STOVE	245,00 €

Prix indiqués hors TVA et hors frais de transport.
Prices excluding VAT and excluding transport costs .

Schéma - Vue éclatée

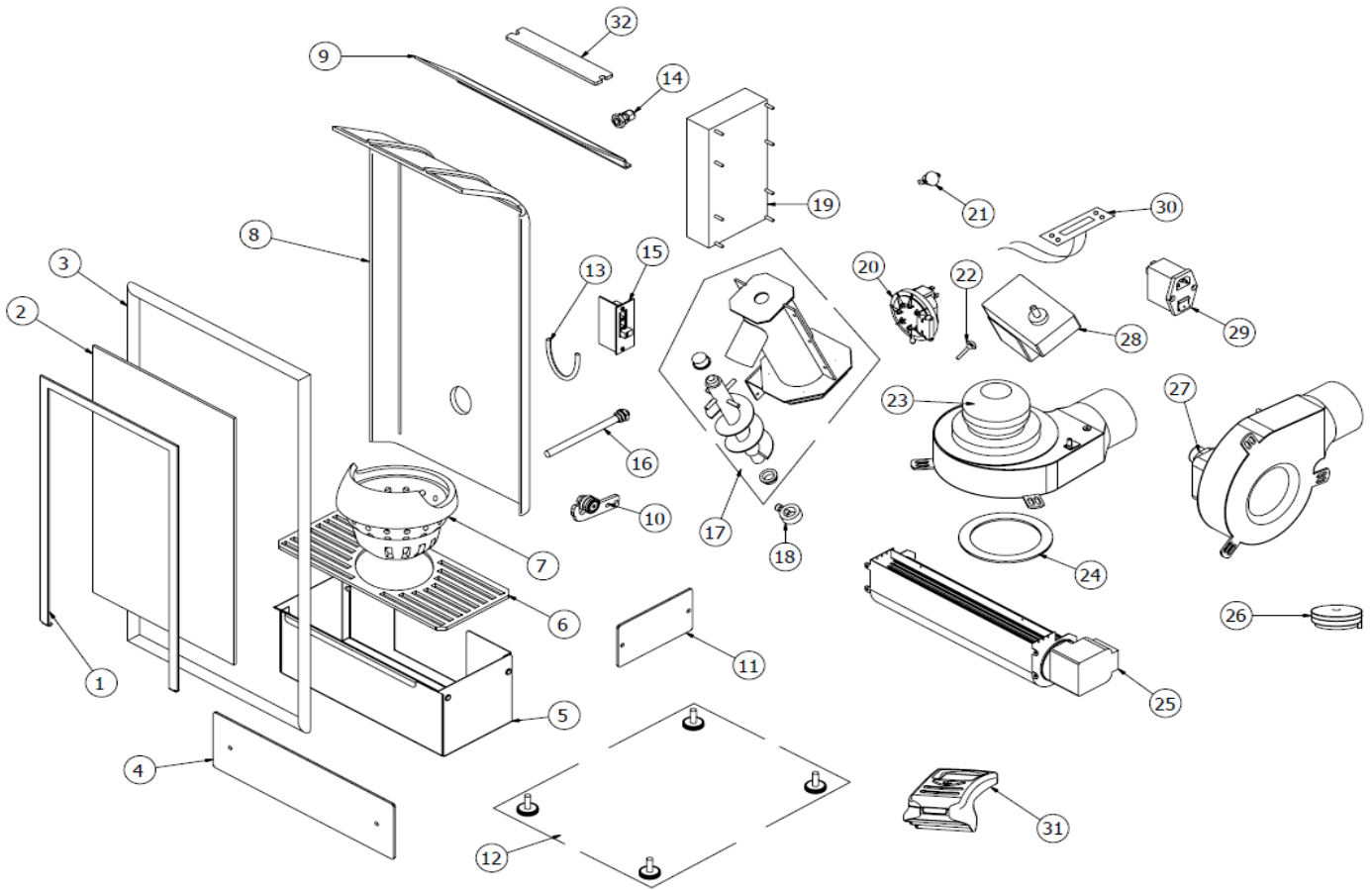

SÛTI brand of GEA INVEST | Fabriqué & Distribué par **DISTRIBUÉ** | siège social : 279 Bushaye - 4880 AUBEL - Belgique |
www.suti.be | suti@suti.be | TVA BTW BE0 644.857.879 | <https://www.facebook.com/suti.fr/> | Banque IBAN BE04 0689 0414 7131
| tel : 0032 87 330245

RECLAMATIONS ET LITIGES

Nous suggérons que nos clients contrôlent la marchandise livrée et le bon de livraison à la réception (c.a.d. en présence du transporteur). Toute réclamation due au transport sera acceptée seulement si mentionnée par écrit sur la copie du transporteur du bon de livraison. Toute réclamation pour marchandise manquante, erronée ou incomplète doit être communiquée au transporteur sur le bon de livraison. Une copie de la réclamation doit être envoyée à Distri&design srl 'SÛTI' Dans le cas de dommages cachés, la réclamation sera prise en compte seulement si transmise au transporteur et à Distri&design srl 'SÛTI' dans 8 jours après la réception. Distri&design srl 'SÛTI' assure la garantie en conformité à la directive européenne 1999/44/EG. À cause de leur nature, les parties en pierre et bois (la pierre & bois sont des matériaux naturels avec de possibles variations esthétiques et chromatiques, p. ex. couleurs, tons, structure et possibles inserts fossiles), les éléments en majolique (produits faits à la main avec de possibles variations de couleur et de ton ; craquelée, légères nuances, points ou bulles sont typiques de ce matériel), parts en acier (si traitées spécialement peuvent montrer de légères nuances), et éléments en bois (matériel naturel avec qualités différentes comme petites fissures et différences de niveau) sont exclues de la garantie et de tout droit à réclamations. Tout échantillon et pièce d'exposition sont seulement des exemples indicatives de la couleur, des dimensions et de la qualité des produits. Des éventuelles différences n'autorisent pas le client ou le revendeur à réclamer la garantie à Distri&design srl 'SÛTI'. Les photos des revêtements dans le catalogue et les couleurs du marbre sont seulement approximatifs. Toute réclamation concernant des factures sera considérée seulement si transmise par écrit dans 30 jours de la date de la facture en question. Distri&design se réserve le droit d'effectuer des changements aux produits sans préavis. Distri&design se réserve le droit d'apporter des modifications de prix sans préavis, si les coûts de main d'oeuvre et des matières premières le rendent nécessaire. Pour tout litige dérivant de ce contrat le tribunal compétent est celui de Liège Belgique. Le « E-commerce », dans les formes « B to B » (business-to-business) et « B to C » (Business to consumer) est un système indépendant de commerce sans limites territoriales et réglé par des conditions spécifiques. Pour cette raison et étant donné l'intérêt de Distri&design à gérer directement ce type de commerce, et en considération de la nécessité de protection de la marque et du nom de l'entreprise dans le E-commerce, ce système de vente ne devra pas être utilisé.

RECLAMATIONS & LITIGATIONS

We suggest our customers to check the goods delivered and the delivery note at the reception (meaning, in the presence of the carrier). Any claim due to carriage will be accepted if and only if mentioned in writing on the carrier's copy of the delivery note. Any claim for missing, erroneous or incomplete merchandise must be communicated to the carrier on the delivery note. A copy of the complaint must be sent to Distri & Design SRL 'SÛTI' in case of hidden damage, the complaint will be taken into account only if transmitted to the carrier and to Distri & Design SRL 'SÛTI' within 8 days after receipt. Distri & Design SRL 'SÛTI', ensures the guarantee in accordance with the European directive 1999/44 / EG. Due to their nature, the stone and wood parts are natural materials with possible aesthetic and chromatic variations (for example: colors, tones, structures and possibilities of fossil inserts). Handmade majolica elements have possible variations of colors and tones (for example: cracked, light shades, dots or bubbles). Specially treated steel elements may have slight shades. Finally, the wooden elements are natural materials of different qualities and may have small cracks or differences in levels. These natural elements are excluded from the warranty and any claims. All samples and exhibits are only indicative examples of the color, size and quality of the products. Any differences do not entitle the customer or the dealer to claim the guarantee from Distri & Design SRL 'SÛTI'. The photos of the coverings in the catalog and the colors of the marble are only approximate. All invoice claims will only be considered if sent in writing within 30 days of the date of issue of this invoice. Distri & Design reserves the right to make product changes without prior notice. Distri & Design, reserves the right to make price changes without prior notice if the cost of labor and raw materials make it necessary. For any dispute arising from this contract the court of jurisdiction is the one of Liège-Belgium. "B to B" (business to business) and "B to C" (business to consumer) is an independent trading system with no territorial boundaries and is regulated by specific conditions. Distri & Design wishes to manage this type of business personally and directly, and due to the need to protect the brand and the name of the company in the E-commerce, the marketing of "SÛTI" on the Internet by a third party will be prohibited.